

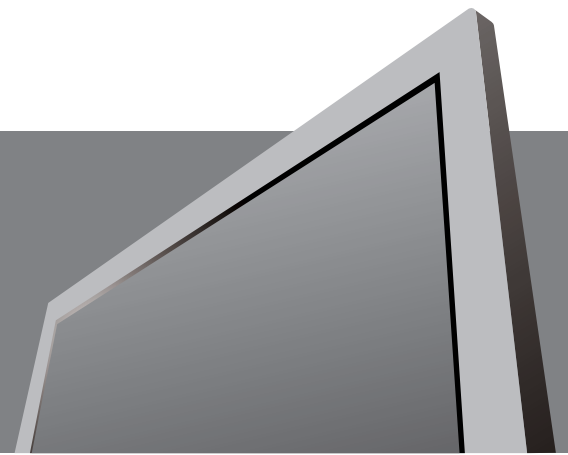

# LED TV

MODEL: FL40107

## USER MANUAL



### **IMPORTANT**

Please read this manual carefully before installing and operating the TV.  
Keep this manual handy for further reference

# Table Of Contents

<b>Preparations Guide</b>	
Safety Information.....	2
Important Safety Precautions.....	3
<b>Installed And Connected TV</b>	
TV Bracket assemble.....	4
TV Buttons And Terminal Interface .....	5
External device connect ion diagram.....	6
Install And Connect TV.....	7
TV St and installation Instructions.....	7
<b>TV Menu</b>	
First Time Installation.....	8
Channel Menu.....	10
Picture Menu.....	14
Sound Menu.....	16
Time Menu.....	17
Lock Menu.....	19
Hotel Mode.....	21
Setup Menu.....	22
<b>PC Menu</b>	
Screen Menu.....	25
<b>Media Menu</b>	
Media Operation .....	26
Photo Menu.....	27
Music Menu.....	28
Movie Menu.....	29
Text Menu.....	30
<b>Other Information</b>	
Help.....	31
Remote Controller.....	32

This user manual for reference only

# Safety Information

## CAUTION

**RISK OF ELECTRIC SHOCK  
DO NOT OPEN**

High voltages are used in the operation of this product. to reduce the risk of electric shock, do not remove cover of the cabinet, refer servicing to qualified service personal

If the TV any changes or coarse adjustment, electric shocks to be hurt, do not attempt to open a machine-maintenance, customer contact centres needed overhaul.



The exclamation point within an equilateral triangle is intended to alert the user to the presence of important operating in the literature accompanying the appliance.

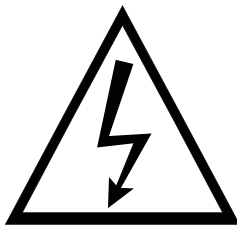

**Warning**  
The lightning flash with arrowhead symbol within an equilateral triangle, is intended to alert the user to the presence of uninsulated dangerous voltage within the products enclosure that may be of sufficient magnitude to constitute a risk of electric shock to persons.

# Important Safety Precautions

- 1) Read these instructions.
- 2) Keep these instructions.
- 3) Heed all warnings.
- 4) Follow all instructions.
- 5) Do not use this apparatus near water.
- 6) Clean only with dry cloth.
- 7) Do not block any ventilation openings. Install in accordance with the manufacturer's instructions.
- 8) Do not install near any heat sources such as radiators, heat registers, stoves, or other apparatus (including amplifiers) that produce heat.
- 9) Do not defeat the safety purpose of the polarized or grounding-type plug. A polarized plug has two blades with one wider than the other. A grounding type plug has two blades and a third grounding prong. The wide blade or the third prong are provided for your safety, If the provided plug does not fit into your outlet, consult an electrician for replacement of the obsolete outlet.
- 10) Protect the power cord from being walked on or pinched particularly at Plugs, convenience receptacles, and the point where they exit from the apparatus.
- 11) Only use attachments /accessories specified by the manufacturer.
- 12) Use only with the cart, stand, tripod, bracket, or table specified by the manufacturer, or sold with the apparatus. When a cart is used caution when moving the cart/apparatus combination to avoid injury tip-over.



- 13) Unplug this apparatus during lightning storms or when unused for long periods of time.

#### Caution:

- 14) To reduce the risk of fire or electric shock, do not expose this apparatus to rain or moisture.
- 15) The mains plug is used as disconnect device, the disconnect device shall remain readily operable.
- 16) The socket-out shall be installed near the equipment and shall be easily accessible.
- 17) This product should never be placed in a built-in installation such as a bookcase or rack unless proper ventilation is provided or the manufacture's instructions have been adhered to.
- 18) The apparatus shall not be exposed to dripping or splashing and that no objects filled with liquid, such as vases, shall be placed on the apparatus.
- 19) Do not place any sources of danger on the apparatus (e.g. liquid filled objects, lighted candles).
- 20) Wall or Ceiling Mounting - The appliance should be mounted to a wall or ceiling only as recommended by the manufacturer.
- 21)  Never place the TV, remote control or batteries near naked flames or other heat sources, including direct sunlight. To prevent the spread of fire, keep candles or other flames away from the TV, remote control and batteries at all times.
- 22) The USB terminal should be loaded with 0.5 A under normal operation.

These servicing instructions are for use by qualified service personnel only. To reduce the risk of electric shock do not perform any servicing other than that contained in the operating instructions unless you are qualified to do so.

- 23) The battery shall not be exposed to excessive heat such as sunshine, fire or the like.
- 24)  This equipment is a Class II or double insulated electrical appliance. It has been designed in such a way that it does not require a safety connection to electrical earth
- 25) The maximum using environment temperature is 45 degrees.  
The Maximum using altitude is 2000 meters

# TV Bracket assemble

## Fix the TV on the wall

1. First, put the TV on the table smoothly and put some soft cloth on the table to avoid scratching the screen.
2. Use the screw driver to take off the screws which are fixed on the bottom stand (the direction of the arrow, refer to the photo 1). And take off the bottom stand (please take off the screws and bottom stand carefully).
3. Make one bracket which can fix on the wall according to the size of arrow direction of photo 2 and photo 3.
4. Drill four holes properly on the wall (the size only for reference) and put into four screws. (optional parts) Drill four holes properly on the wall (the size only for reference) and put into four screws. (optional parts)
5. according to the step 4, use the screwdriver to lock the screw on the back of the TV. then hang the TV on the wall.

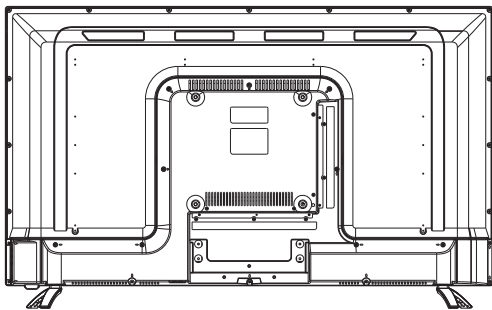

1

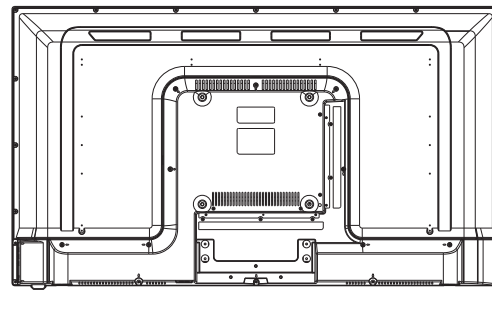

2

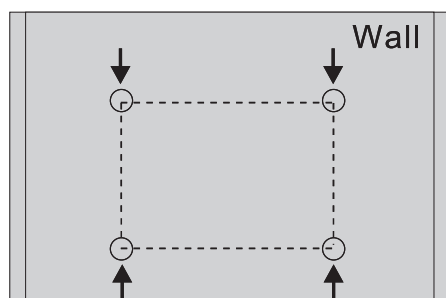

3

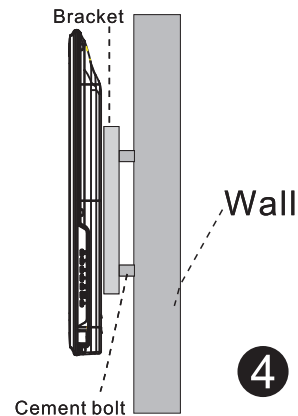

4

## Note:

1. The bracket fixed on the wall is optional part.
2. when you assemble the TV, there should be no other articles on the around and front and please keep the distance from other articles.
3. When assemble the TV, please ask the career man to fix in order to avoid the danger.
4. The fixing picture is only for reference.
5. Please follow the use manual about bracket assemble to fix the TV.
6. Attach the mounting bracket from the VESA compatible wall mounting kit.

# TV Buttons And Terminal Interface

## TV Buttons

Note: The following is only functional schematic, And the actual position and arrangement of different models may be different.



: Turn ON/OFF Power.

**SOURCE**: External Signal Input Selection.

**MENU**: Display Main MENU And Confirm MENU Item Selection.

**CH+/-**: Selecting Channel.

**VOL+/-**: Adjusting Volume.

## Terminal Interface

Note: The following are the various terminal interface, the actual position and arrangement, the number of different models may be different.

	<b>AV input</b> External AV Signal Input And Relevant Right/Left Sound Channel		<b>EARPHONE output</b> When earphones are plugged in, speakers are disabled
	<b>CI SLOT</b> The card reader input CI (common interface) this requires CAM (conditional access module) used for pay TV.		<b>USB input</b> Connect a USB device here to play its media files or to record programs via the PVR function.
	<b>Y Pb Pr input</b> Connect to the composite terminal of your DVD/VCR (Some models without this interface)		<b>COAXIAL</b> Connect the SPDIF receiver.
	<b>HDMI input</b> Digital signal input from HDMI video connector.		<b>SCART input</b> standard, it supports composite and RGB signal input. It is a connection for European (Some models without this interface)
	<b>ANT 75</b> Connect the antenna/cable tv input (75/VHF/UHF)		
	<b>VGA input</b> PC analog signal input		
	<b>PC AUDIO INPUT</b> VGA input and audio input when VGA input		

# External device connection diagram

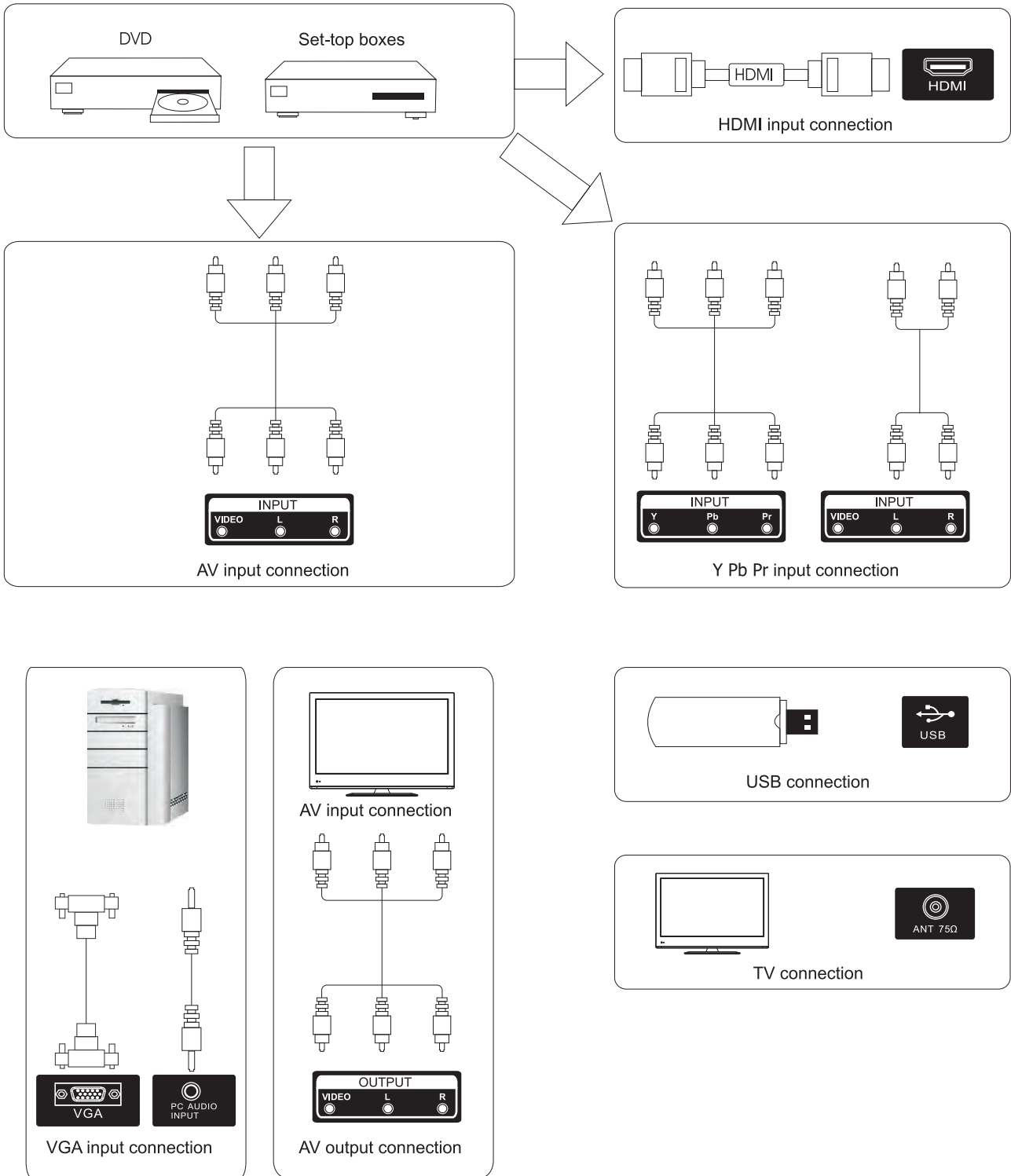

# Install And Connect TV

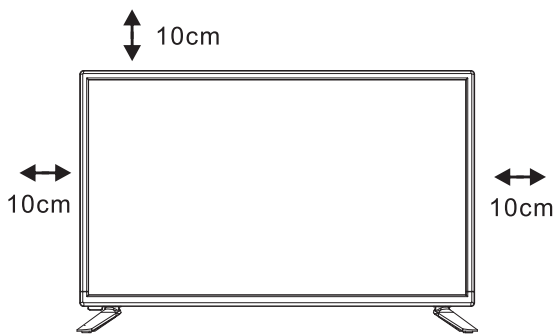

3

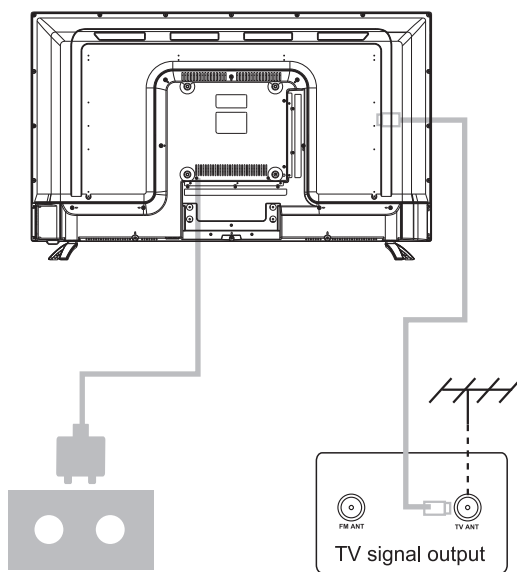

## Set your TV

To put your TV in a firm place which can bear the weight of the TV.

To avoid danger, please don't expose the TV near water or heating place (such as light, candle, heating machine), do not block the ventilation at the back of TV.

## Connect antenna and power

1. Connect the antenna cable to the antenna socket on the back of the TV.
2. To plug the power cord of TV.

## Turn on TV

3. Press the power button of the TV the indication light will turn to green. if it is on standby mode (the light is red), press the power button on the remote control to turn on the TV.

## Note:

Picture for reference purposes only.

# TV Stand Installation Instructions

1. Open the carton and remove the TV and scattered accessories and base (some models without base).
2. To avoid the injury of the TV, covered with a soft mattress, put it on the table, face down on a soft mattress, the base of the neck is fixed on the TV with screws.
3. Screw the base and connected to the TV.
4. The installation is complete.

## Note:

Picture for reference purposes only.

Please prevail in kind

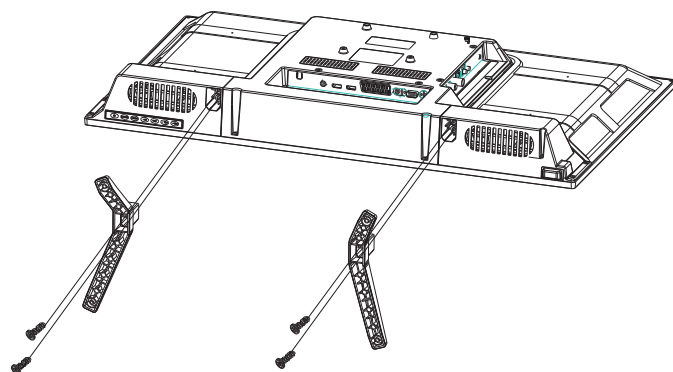

# First Time Installation

Connect an RF cable from the Tv's input called "RF-In" and to your TV Aerial socket.

## Select Language

Press ◀ / ▶ button to select the language to be used for menus and message.

## Select Country

Press ▼ / ▲ button to highlight country menu.

Press ◀ / ▶ button to select the country you want to.

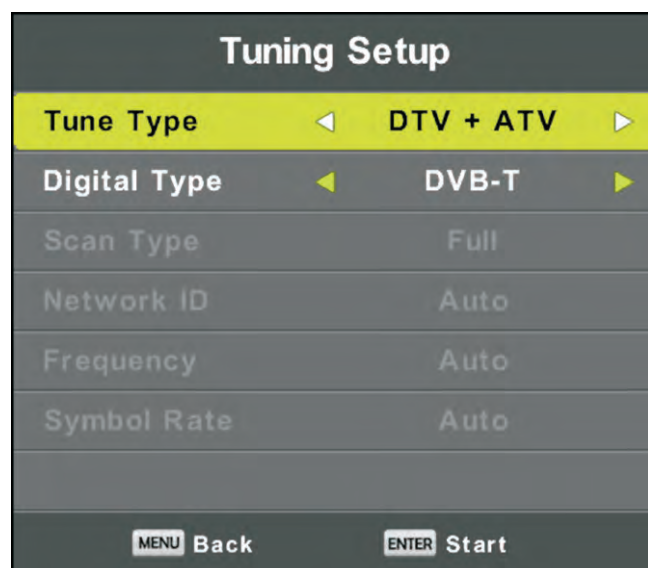
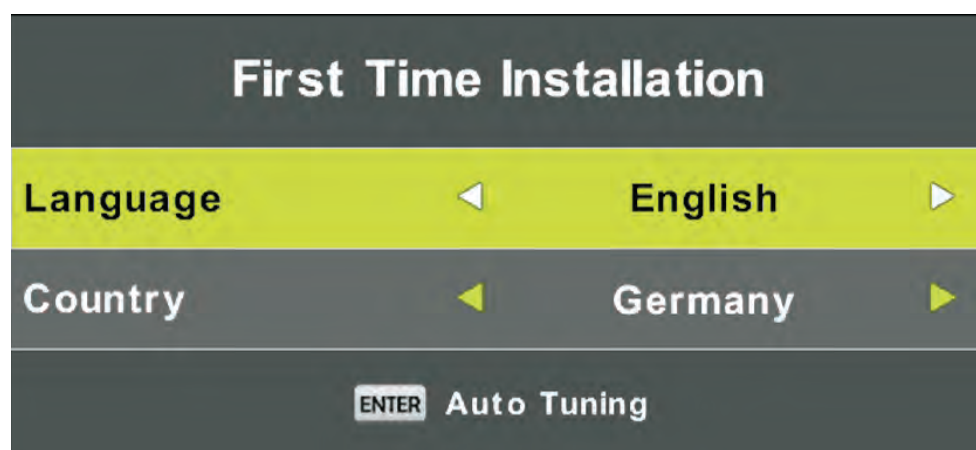



# Main Menu Operation

## Channel Menu

Press **MENU** button to display the main menu.  
Press ◀/▶ button to select **CHANNEL** in the main menu.



1. Press ▼/▲ button to select the option that you want to adjust in the **CHANNEL** menu.
2. Press **Enter** button to adjust.
3. After finishing your adjustment, Press **Enter** button to save and return to the previous menu.

### Auto Tuning

Press ▼/▲ button to select Auto Tuning, then press **Enter/?** button to enter.

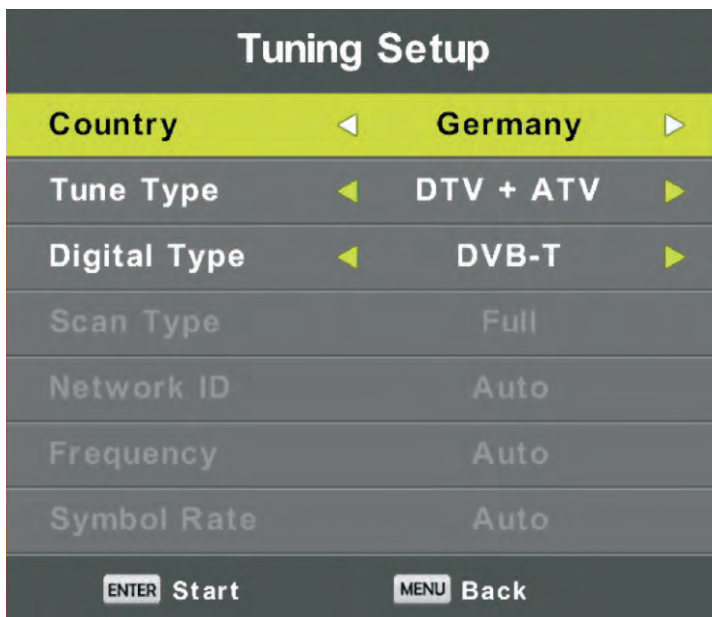



### DTVManual Tuning

Press ▼/▲ button to select DTV Manual Tuning, then press **Enter** button to enter sub-menu.  
Press◀/▶ button to select channel, then press **Enter** button to search program.

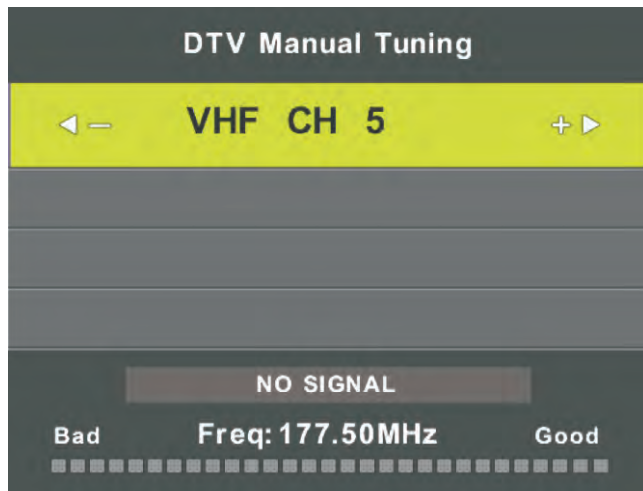

### Program Edit

Press ▼/▲ button to select Program Edit, then press **Enter** button to enter sub-menu.

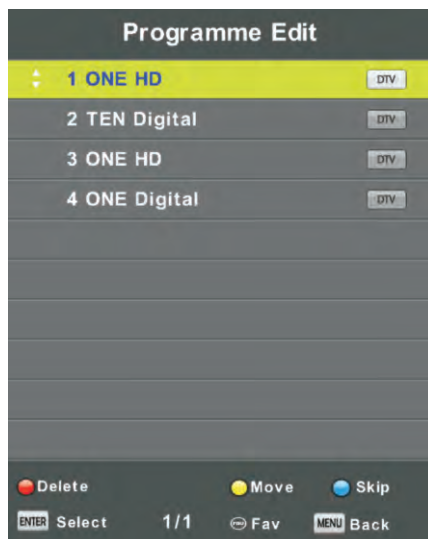

The three colored key is the shortcut key for programming the channel.

First press ▼ / ▲ to highlight the channel you want to select, then:

Press the **Red** button to delete the program in the list.

Press the **Yellow** button to move the channel in favorite list.

Press the **Blue** button to skip the selected channel.

Press Fav button to add or remote the channel to your favorite list.

(Your TV set will skip the channel automatically when using CH+/- to view the channels.)

**Schedule List**

Press ▼/▲ button to select Schedule List, then press **Enter** button to enter sub-menu.  
It is available in source.

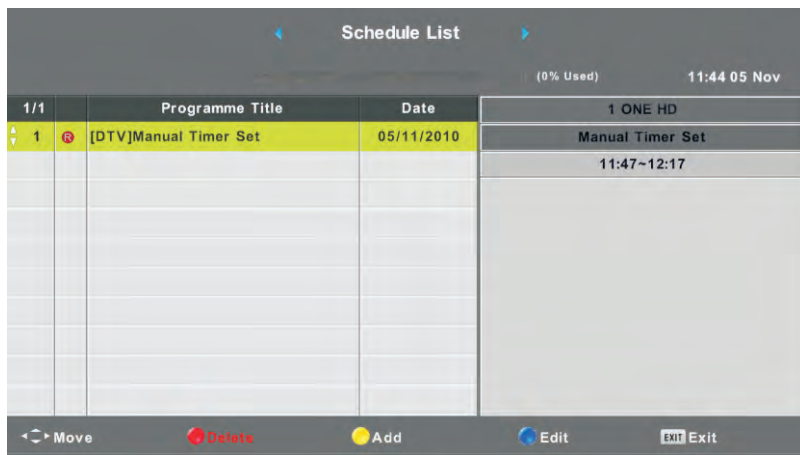

Press the **YELLOW** button to enter the interface below.

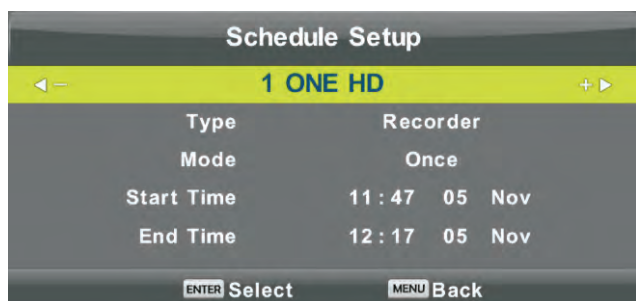

When the time appointment is conflict , it will produce a warning message.



**Signal Information**

Press ▼ / ▲ button to select **Signal Information**, press the **Enter** button to see the detail information about the signal. Only available when there is signal in DTV.

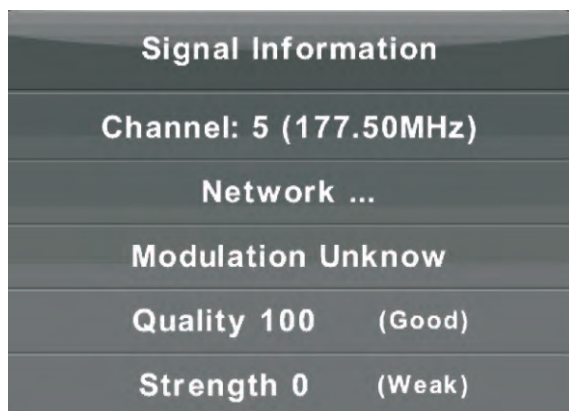

**CI Information(Need to support the CI function)**

Press ▼/ ▲button to select CI Information, then press the Enter button to display detail if you has inserted the CI card

# Picture Menu

Press **MENU** button to display the main menu.  
 Press **◀/▶** button to select **PICTURE** in the main menu.



Note: 120Hz MODE Function only supported with UHD TV

1. Press **▼ / ▲** button to select the option that you want to adjust in the **PICTURE** menu.
2. Press **OK** button to adjust.
3. After finishing your adjustment, Press **MENU** button to save and return back to the previous menu.

## Picture Mode

Press **▼ / ▲** button to select Picture Mode, then press **OK** button to enter sub-menu.

You can change the value of contrast, brightness, color, sharpness and tint when the picture is in **Personal** mode.

TIPS: You can press **PMODE** button to change the Picture Mode directly.



## Contrast/ Brightness/ Color/ Tint / Sharpness

Press **▼ / ▲** button to select option, then press **? / ?** button to adjust.

- Contrast** Adjust the highlight intensity of the picture, but the shadow of the picture is invariable.
- Brightness** Adjust the optical fiber output of the entire picture, it will effect the dark region of the picture.
- Color** Adjust the saturation of the color based on your own like.
- Tint** Use in compensating color changed with the transmission in the NTSC code.
- Sharpness** Aadjust the peaking in the detail of the picture.

## Color Temp



Change the overall color cast of the picture.

Press ▼ / ▲ button to select Color Temperature , then press **OK** button to enter sub-menu.

Press ◀ / ▶ button to select. (Available Picture mode: Cool, Medium, Warm). You can change the value of red,green and blue when the color temperature is in **User** mode.

**Cold** Increase the blue tone for the white.

**Normal** Increase the sex-linked colors for the white.

**Warm** Increase the red color for the white.

## Noise Reduction



To filter out and reduces the image noise and improve picture quality.

Press ▼ / ▲ button to select Noise Reduction, then press **OK** button to enter sub-menu.

**Off** Select to turn off video noise detection.

**Low** Detect and reduce low video noise.

**Middle** Detect and reduce moderate video noise.

**High** Detect and reduce enhanced video noise.

**Default** Set as Default.

## 120Hz MODE ( Only with UHD TV )



Adjust the motion compensation.

Higher setting may improve the motion performance when watching sports or playing games.

Press ◀ / ▶ button to select(Off/Low/Medium/High)

## HDMI Mode



Press ▼ / ▲ button to select HDMI Mode, then press **OK** button to enter sub-menu.

Press ◀ / ▶ button to select .(Available Picture mode;Auto,Video,PC).

# Sound Menu

Press **MENU** button to display the main menu.  
 Press ◀/▶ button to select **SOUND** in the main menu.



1. Press ▼/▲ button to select the option that you want to adjust in the **SOUND** menu.
2. Press **Enter** button to adjust.
3. After finishing your adjustment, Press **Enter** button to save and return to the previous menu.

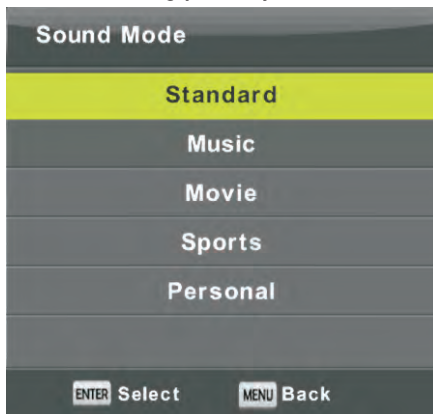

## Sound Mode

Press ▼ / ▲ button to select Sound Mode, then press **Enter** button to enter sub-menu.  
 Press ▼/▲ button to select.

You can change the value of Treble and Bass when the sound is in Personal mode.

TIPS: You can press **SMODE** button on the remote control to change the Sound Mode directly.

Standard	Produces a balanced sound in all environments.
Music	Preserves the original sound. Good for musical programs.
Movie	Enhances treble and bass for a rich sound experience.
Sports	Enhances vocals for sports.
Personal	Select to customize picture settings.

**Note:** The treble and bass are only available in **User** mode, you can adjust them as you like.

## Balance

Press ▼/▲ button to select option, Press ◀/▶ button to adjust.

## Auto Volume level

Press ▼/▲ button to select Auto Volume Level, then press ◀/▶ button to select On or Off.

## SPDIF Mode

Press ▼/▲ button to select SPDIF Mode, then press ◀/▶ button to select Off / PCM / Auto.

## AD Switch

Press ▼/▲ button to select AD Switch, then press ◀/▶ button to select On or Off.  
 Amblyopia function for the blind, the tracks will be mixed describe the current screen .  
 It need codestream to support.

## NOTE:

**Balance:** This item can adjust the speaker's output, it enables you to listen to best at your position.

**Auto Volume:** This item is used for reducing the difference between channel and program's volume automatically.

# Time Menu

Press **MENU** button to display the main menu.  
 Press **◀/▶** button to select **TIME** in the main menu.



1. Press **▼/▲** button to select the option that you want to adjust in the **TIME** menu.
2. Press **Enter** button to adjust.
3. After finishing your adjustment, Press **Enter** button to save and return to the previous menu.

## Time Zone

Press **▼/▲** button to select **Time Zone**, then press **Enter** button to enter sub-menu.

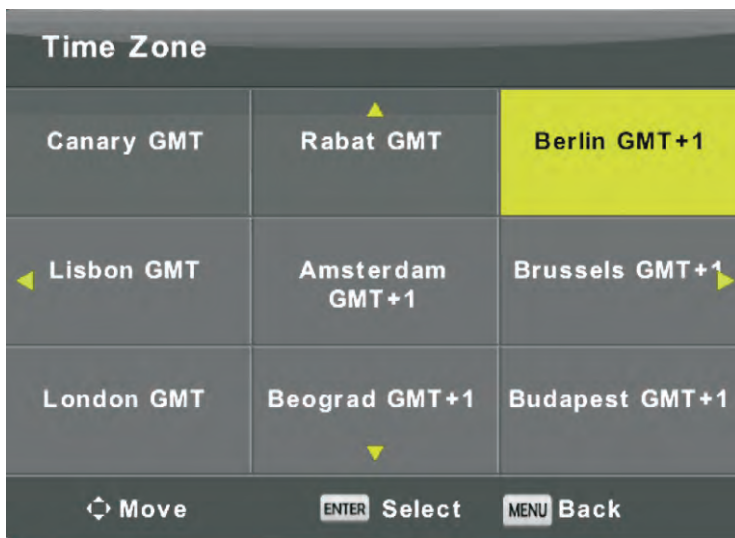

Press **▼ / ▲ / ◀ / ▶** button to select time zone.

## Sleep Timer

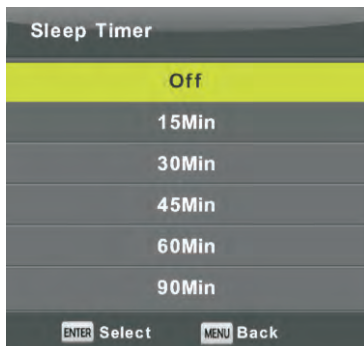

Press **▼/▲** button to select **Sleep Timer**, then press **Enter** button to enter sub-menu.

Press **▼ / ▲** button to select.  
 (Available options are: Off, 10min, 20min, 30min, 60min, 90min, 120min, 180min, 240min).

## Auto Standby

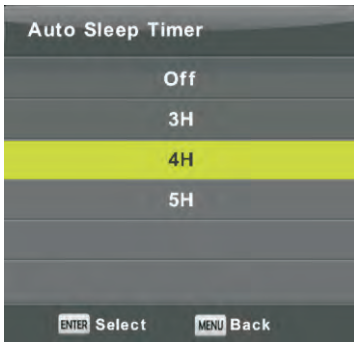

Press ▼/▲ button to select Auto Standby , then press **Enter** button to enter sub-menu.

Press ▼/▲ button to select.

Tips: The remote control does not make any operation in the hypothesis time, it will close down automatically. If you do any operation, it will reset the time.

## OSD Timer



Press ▼/▲ button to select OSD Timer , then press **Enter** button to enter sub-menu.

Press ◀ / ▶ button to select.

# Lock Menu

Press **MENU** button to display the main menu.  
Press **◀/▶** button to select **Lock** in the main menu.



1. Press **▼/▲** button to select the option that you want to adjust in the **LOCK SYSTEM** menu.
2. Press **Enter/◀/▶** button to adjust.
3. After finishing your adjustment, Press **MENU** button to return back to the previous menu

# Lock System

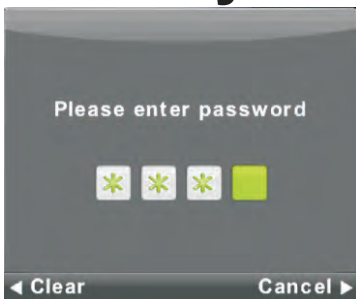

Press **▼ / ▲** button to select Lock System, then press **Enter** button to make the following 3 options valid.

Default password is 0000, and if forget what you set, please call the service center.

## Set Password



Press **▼ / ▲** button to select Set Password, then press **Enter** button to enter sub-menu to set new password.

# Channel Lock

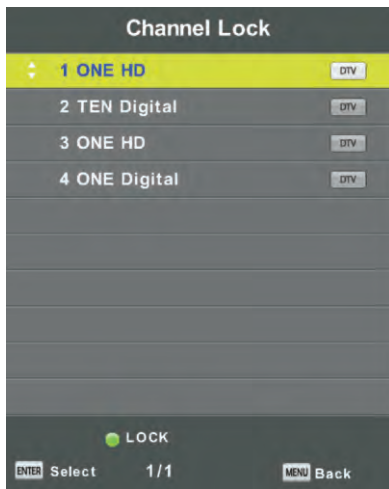

Press ▼ / ▲ button to select Channel Lock then press **Enter** button to enter sub-menu to select. Press **Green** button to lock or unlock the channel.

## Parental Guidance

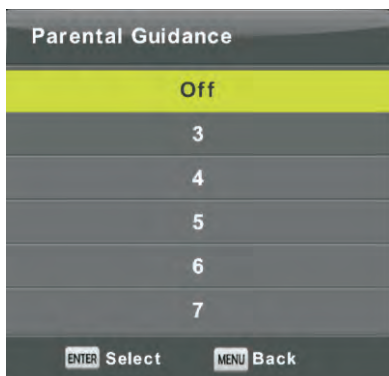

Press ▼ / ▲ button to select Parental Guidance, then press **Enter** button to enter sub-menu to select the number of age which is suitable for your children.

## Key Lock

Press ▼ / ▲ button to select Key Lock, then press ◀ / ▶ button to select Off or On. When Key Lock's statue is on, you can't use the Key panel button.

## Hotel Mode

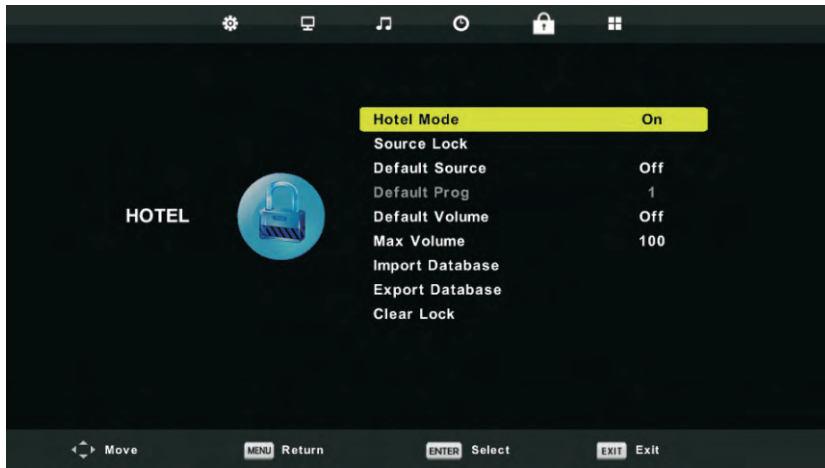

1. Press **▼ / ▲** button on the remote control to select hotel mode in the **Lock** menu.
2. Press **Enter** button on the remote control to enter the sub-menu.
3. After finishing your adjustment, Press **MENU** button to save and return back to the previous menu.

### Hotel Mode

Press **▼ / ▲** button to select Hotel Mode, then press **◀ / ▶** button to select on or off.

### Source Lock

Press **▼ / ▲** button to select Source Lock, then press **Enter** button to enter sub-menu to select.

### Default Source

Press **▼ / ▲** button to select Default Source, then press **Enter** button to enter sub-menu to select.

### Default Prog

Press **▼ / ▲** button to select Default Prog, then press **◀ / ▶** button to adjust.  
It is available when the default source is TV.

### Max Volume

Press **▼ / ▲** button to select Max Volume, then press **◀ / ▶** button to adjust.

### Clear Lock

Press **▼ / ▲** button to select Clear Lock, then press **Enter** button to clear the setting you have done before.

# Setup Menu

Press **MENU** button to display the main menu.  
Press **◀/▶** button to select **SETUP** in the main menu.



1. Press **▼/▲** button to select the option that you want to adjust in the **SETUP** menu.
2. Press **Enter** button to adjust.
3. After finishing your adjustment, Press **Enter** button to save and return to the previous menu.

## OSD Language

Select an OSD menu language can be displayed. Default English is selected as menu language.

Press **▼ / ▲ / ◀/▶** button to select Menu Language.

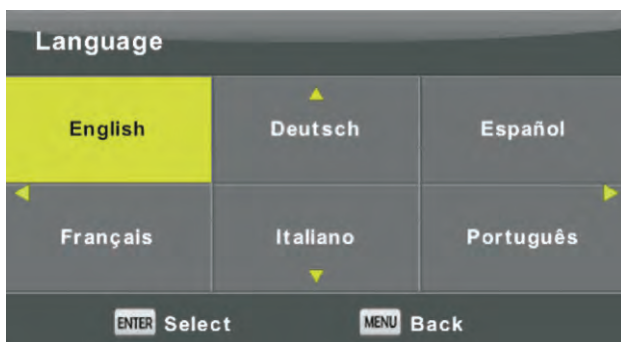

## TT Language

Press **▼ / ▲** button to select TT Language, then press **Enter** button to enter sub-menu.  
Press **▼ / ▲ / ◀/▶** button to select TT language.



### Audio Languages

Press ▼ / ▲ button to select Audio Languages, then press **Enter** button to enter sub-menu.

Press ◀ / ▶ button to select the primary of Audio Languages.

Press ▼ / ▲ / ◀ / ▶ button to select the Audio Languages.



### Subtitle Language

Press ▼ / ▲ button to select Subtitle Language, then press **Enter** button to enter sub-menu.

Press ◀ / ▶ button to select the primary of Subtitle Language.

Press ▼ / ▲ / ◀ / ▶ button to select the Subtitle Language.



### Hearing Impaired

Press ▼ / ▲ button to select Hearing Impaired, then press **Enter** button to select On or Off.

### PVR File System

Press ▼ / ▲ button to select PVR File System, then press **Enter** button to enter sub-menu.

Press ▼ / ▲ button to select Check PVR File System, then press **Enter** button to enter. Then it will check the USB speed.



### Aspect Ratio

Press ▼ / ▲ button to select Aspect Ratio , then press **Enter** button to enter sub-menu.  
Press ▼ / ▲ button to select aspect ratio. (Available options are: Auto, 4:3, 16:9, Zoom1, Zoom2).



### Blue Screen

Press ▼ / ▲ button to select Blue Screen, then press **Enter** button to select On or Off.

### First Time Installation

Press ▼ / ▲ button to select First time installation, then press **Enter** button to enter.

### Reset

Press ▼ / ▲ button to select Reset, then press **Enter** button to enter sub-menu.

### Software Update(USB)

Press ▼ / ▲ button to select Software Update (USB), plug your USB device in the USB slot, then press **Enter** button to update the right software.

### HDMI CEC(Need to support the HDMI CEC/ARC function)

Press ▼ / ▲ button to select HDMI CEC, then press **Enter** button to enter the sub-menu.

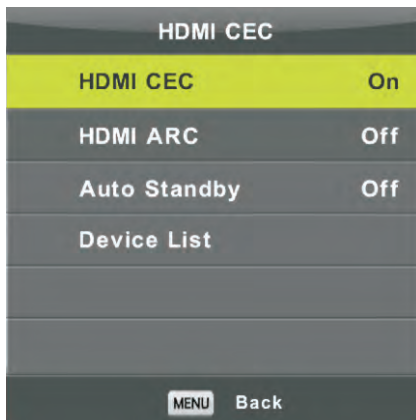

HDMI CEC Press ◀/▶ button to turn the HDMI CEC on or off.

HDMI ARC Press◀ /▶ button to turn the HDMI ARC on or off.

Auto Standby Press◀ /▶ button to turn the Auto Standby on or off.

Device List Press **Enter** button to open the main menu of device.

# Screen Menu

Press **MENU** button to display the main menu.  
Press ◀/▶ button to select **SCREEN** in the main menu.



1. Press ▼/▲ button to select the option that you want to adjust in the **SCREEN** menu.
2. Press **Enter** button to adjust.
3. After finishing your adjustment, Press **Enter** button to save and return to the previous menu.

## Auto Adjust

Press **Enter** button to start adjusting **H-Offset/V-Offset/Size/Phase** automatically.

## H-Offset

Adjust the horizontal position of the picture.

Press ▼ / ▲ button to select **H-Offset**, then press **Enter** button to enter sub-menu.

## V-Offset

Adjust the vertical position of the picture.

Press ▼ / ▲ button to select **V-Offset**, then press **Enter** button to enter sub-menu.

## Size

Adjust the display size.

Press ▼ / ▲ button to select **Size**, then press **Enter** button to enter sub-menu.

## Phase

Adjust the horizontal interfering lines.

Press ▼ / ▲ button to select **Phase**, then press **Enter** button to enter sub-menu.

## Position Reset

Press ▼ / ▲ button to select **Position Reset**, then press **Enter** button to enter.

### Notes:

1. Noise Reduction in PICTURE option is invalid.
2. AD Switch in SOUND option is invalid.
3. TIME menu and description are the same as that for Air mode.
4. Block Program and Parental Guidance in LOCK option is invalid.
5. Audio Languages, Subtitle Language, Hearing Impaired and PVR File System in SETUP option is invalid.
6. PC mode has no CHANNEL menu.

## Media OPERATION

Note: Before operating **Media** menu, Plug in USB device, then press INPUT button to set the Input Source to **Media** .

Press ▼ / ▲ button to select **Media** in the Source menu, then press **Enter** button to enter.



Press ◀ / ▶ button to select the option you want to adjust in the main **Media** menu, then press **Enter** button to enter.

# Photo Menu

Press ◀/▶ button to select PHOTO in the mainmenu, then press **Enter** button to enter.

Press **Exit** button to return to the previous menu and exit menu to quit.

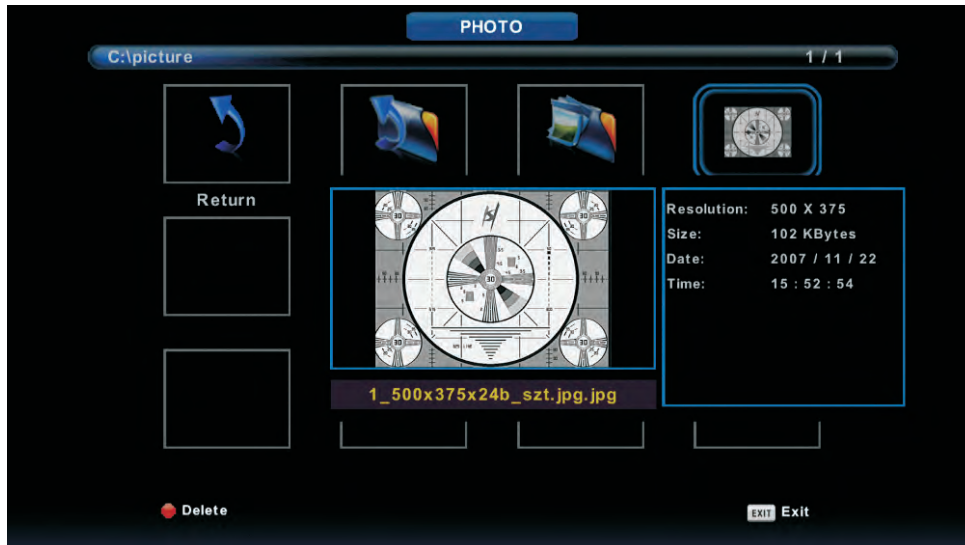

Press ◀/▶ button to select the file you want to watch in the file selecting menu, then press media button to display picture.

When highlighting the option you select, the file information will appear on the right and picture will be previewed in the center.

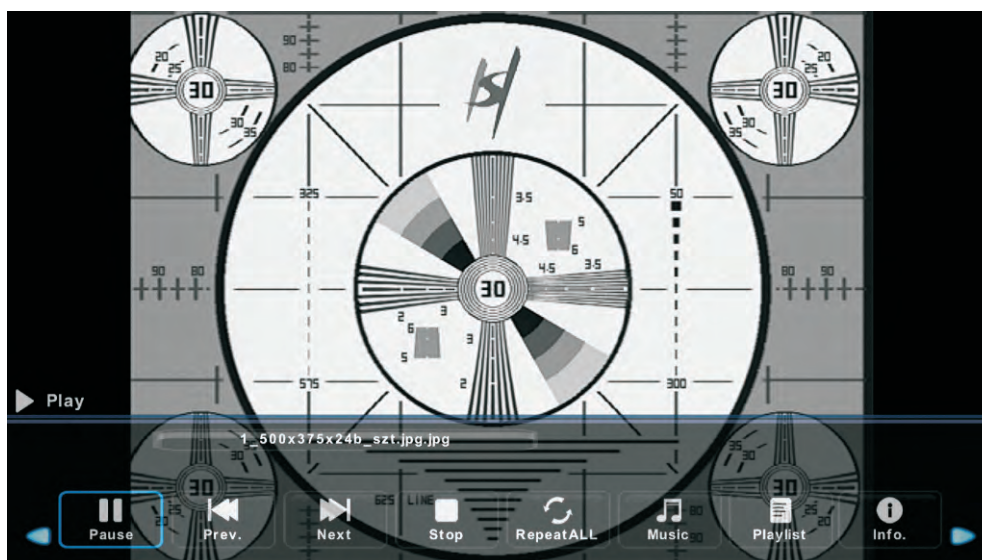

# Music Menu

Press ◀/▶ button to select MUSIC in the mainmenu, then press **Enter** button to enter.

Press **Exit** button to return to the previous menu and exit menu to quit.



Press ◀/▶ button to select drive disk you want to watch, then press **Enter** button to enter.

Press ◀/▶ button to select return option to the previous menu.



# Movie Menu

Press ◀/▶ button to select MOVIE in the mainmenu, then press **Enter** button to enter.

Press **Exit** button to return to the previous menu and exit menu to quit.



Press ◀/▶ button to select drive disk you want to watch, then press **Enter** button to enter.

Press media button to play the selected movie.

Press display button to select menu in the bottom you want to run, then press **Enter** button to operate.

Press **Exit** button to back to the previous menu and exit button to quit the entire menu.

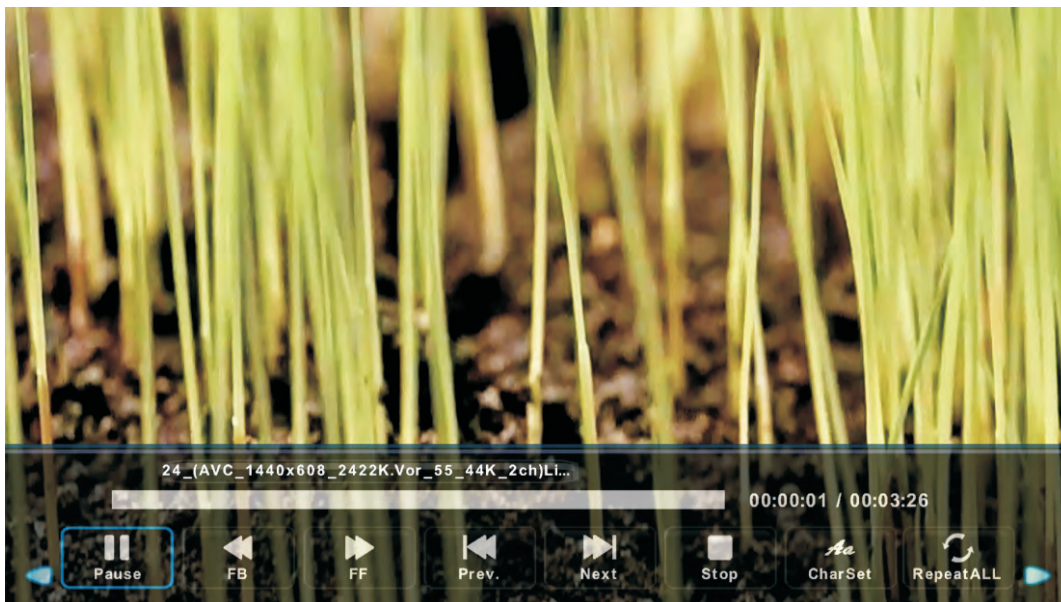

# Text Menu

Press ◀/▶ button to select TEXT in the mainmenu, then press **Enter** button to enter.

Press **Exit** button to return to the previous menu and exit menu to quit.



Press ◀/▶ button to select drive disk you want to watch, then press **Enter** button to enter.

Press ◀/▶ button to select return option to back to the previous menu.

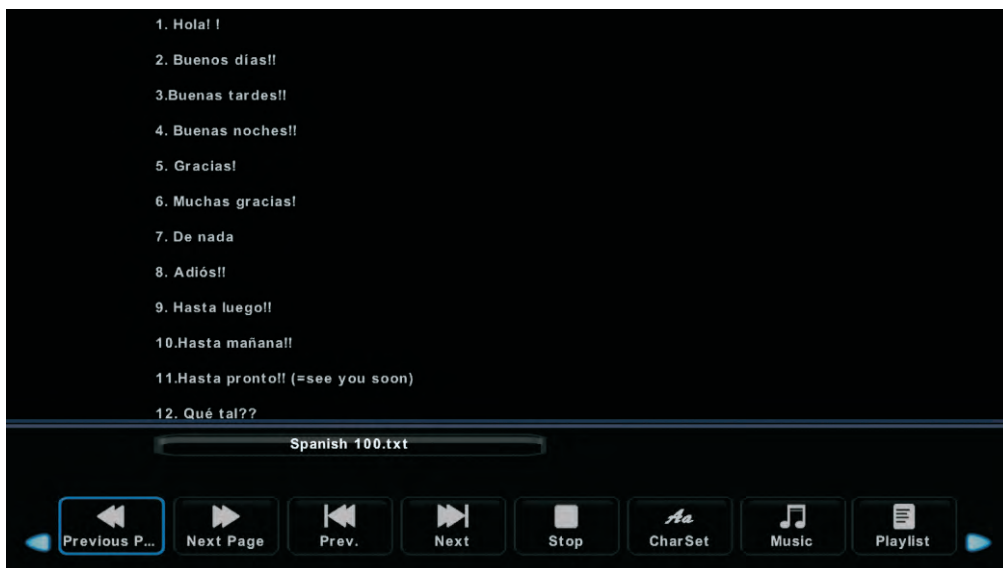

# Help

No power	<ul style="list-style-type: none"> <li>• Check if the AC cord of TV is plugged in or not. If there's still no power, please disconnect the plug, and reconnect to the socket after 60 seconds. Turn the power back on.</li> </ul>
Signal not received properly	<ul style="list-style-type: none"> <li>• Double or phantom images may appear on your TV if there are high buildings or mountains close to where you are. You can adjust the image thru manual operation: consult instruction of vernier regulation, or adjust the direction of the external antenna.</li> <li>• If you use an indoor antenna, under certain circumstances signal reception may be more difficult. Adjust the direction of the antenna for optimum reception. If this does not improve reception, you may have to switch to an external antenna.</li> </ul>
No picture	<ul style="list-style-type: none"> <li>• Check if the antenna at the back of the TV is connected properly.</li> <li>• View other channels to see if the problem still occurs.</li> </ul>
Video appears with no audio	<ul style="list-style-type: none"> <li>• Try increasing the volume.</li> <li>• Check if the TV's sound is on mute or not.</li> </ul>
Audio is present, but video does not appear or is discolored	<ul style="list-style-type: none"> <li>• Try adjusting the contrast and brightness.</li> </ul>
Static noise affects video and audio quality	<ul style="list-style-type: none"> <li>• Check if the antenna at the back of the TV is connected properly.</li> </ul>
Broken lines on screen	<ul style="list-style-type: none"> <li>• Electrical appliances such as hair dryers or vacuums etc. may be interfering with your TV set. Switch these appliances off.</li> </ul>
Remote doesn't work	<ul style="list-style-type: none"> <li>• Make sure the plastic bag which came with the remote control is removed. Try using the remote in a shorter distance from the TV. Check if the placement of the batteries is correct, or try using new batteries with the remote control.</li> <li>• The TV will go into Standby mode if it receives no response in a few minutes.</li> </ul>
No video (PC mode)	<ul style="list-style-type: none"> <li>• Please check if the cable is connected to the VGA port correctly, or if the cable is bent in some places.</li> </ul>
Vertical line blinking (PC Mode)	<ul style="list-style-type: none"> <li>• Enter the main menu, and adjust the vertical placement to eliminate the vertical line.</li> </ul>
Horizontal tearing (PC Mode)	<ul style="list-style-type: none"> <li>• Adjust the horizontal placement of the screen to clear any horizontal lines.</li> </ul>
Screen is too bright or dark (PC Mode)	<ul style="list-style-type: none"> <li>• Adjust the brightness or contrast in the main menu.</li> </ul>
No response from the PC	<ul style="list-style-type: none"> <li>• Check if the PC's display resolution is set to a compatible resolution for the TV.</li> </ul>
Lines appearing when a device is connected to the RCA port	<ul style="list-style-type: none"> <li>• Make sure you are using a cable of good quality.</li> </ul>
Problems are unresolved	<ul style="list-style-type: none"> <li>• Unplug the power cable and wait for 30 seconds, then reconnect to the socket. If problems still persist, do not attempt to repair the TV by yourself. Kindly contact the service center.</li> </ul>

Do not leave your TV displaying a static image, whether it is from a paused video, menu screen, etc. for an extended period of time, doing so will damage the display and may cause image burn-in.

# Remote Controller

1. **POWER:** Sets your TV to power on or standby mode.
2. **MUTE:** Press to mute the sound. Press again or press VOL+ to unmute.
3. **0-9:** Press 0~9 to select a TV channel directly while watching TV. The channel will change after 2 seconds. Applicable for entering page number in teletext mode and so on.
4. **DTV/ATV:** Switch between analog and digital TV.
5. **↶:** Return to the previous viewed program.
6. **S.MODE:** Press to cycle through the different sound settings.
7. **SLEEP:** Select the amount of time before TV turns itself off automatically.
8. **MTS:** Press to search the NICAM mode.
9. **P.MODE:** Press to cycle through the different picture settings.
10. **MENU:** Allows you to navigate to the on-screen menus.
11. **SOURCE:** Opens the main menu, press to list the sources.
12. **▲▼◀▶ ENTER:** Allows you to navigate the on-screen menu and adjust the system settings to your preferences.
13. **EXIT:** Exits from the menu or sub-menu and cancels the function in process (if applicable).
14. **DISPLAY:** Press to display the source and channel's info.

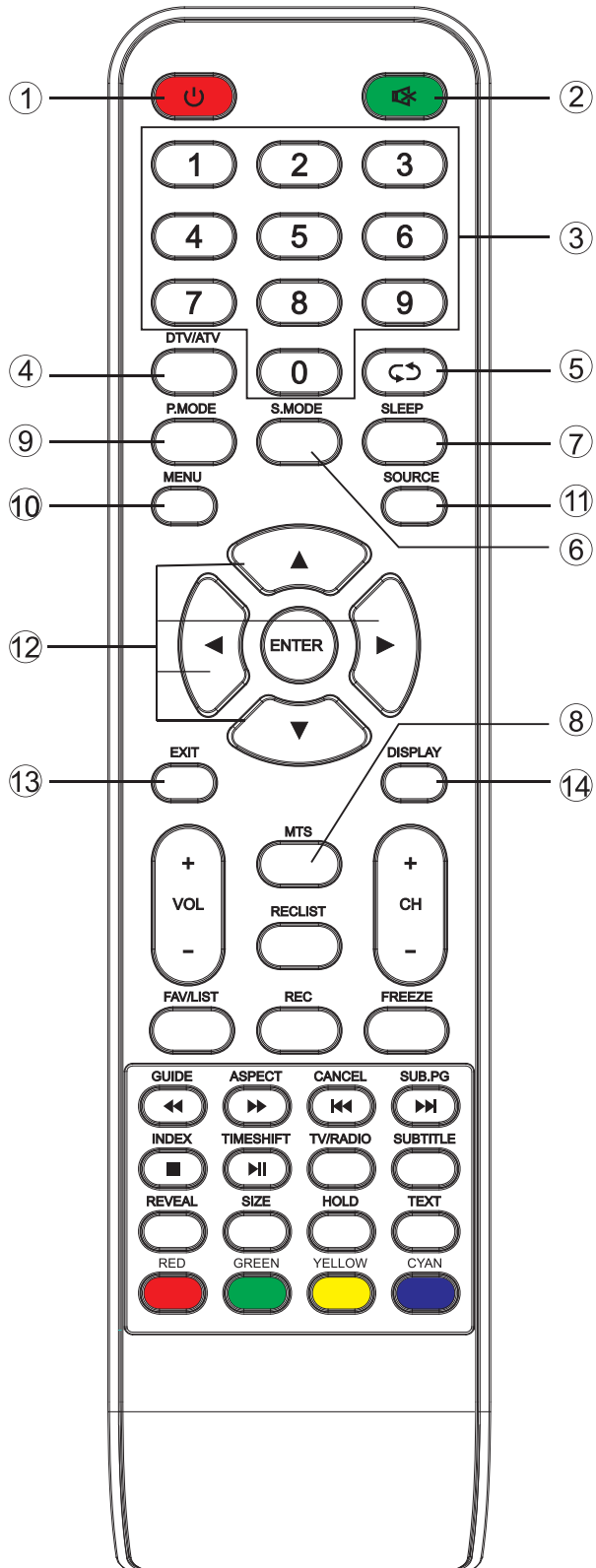

## Battery Installation:

Remove the battery compartment lid on the rear of the remote control by sliding the lid down, then off. Put two AAA batteries inside the battery compartment with their + and – ends aligned as indicated. Do not mix old and new batteries or different types of batteries. Slide the lid until you hear it click into place.

# Remote Controller

1. **VOL+/VOL-**: Press to increase/ decrease the sound level.
2. **TV/RADIO**: When watching a channel, allows you to switch between TV and Radio modes.
3. **GUIDE**: 1. Launches the EPG 2. Fast reverse in PVR or Media Player mode.
4. **TIME SHIFT**: 1. DTV channel time shift function. Play on PVR or Media Player mode.
5. **CANCEL**: 1. When a page is selected in the text mode, it may take some time before it becomes available. Pressing the CANCEL key will return to the TV mode. When the required page is found, the page number will appear at the top of the TV picture. Press the CANCEL key to return to the text mode for you to browse this page. 2. Previous chapter in PVR or Media Player mode.
6. **INDEX**: 1. Request the Index page in teletext mode. 2. Previous chapter in PVR or Media Player mode.
7. **SIZE**: Change the size of display in Teletext mode.
8. **REVEAL**: Reveal or hide the hidden words.
9. **COLOR BUTTONS**: Teletext switch of the analog parts, the items selection in the menu of the digital parts and the MHEG5 function in the DVB menu.
10. **CH+/CH-**: Press to scan through channels.
11. **FAV/LIST**: Press to open the favorite list. Then you can select a favorite channel.
12. **ASPECT**: 1. Select picture scale. 2. Fast forward in PVR or media player mode.
13. **FREEZE**: Press to freeze the picture.
14. **SUB.PG**: 1. Press to access a sub-page. Next chapter in PVR or media player mode.
15. **SUBTITLE**: Shows and sets the language of current DTV.
16. **HOLD**: On or off for current page display.
17. **TEXT**: Switches the teletext on and off.
18. **RECLIST**: Shows the recorded list.

19. **REC**: Record begin in PVR mode.

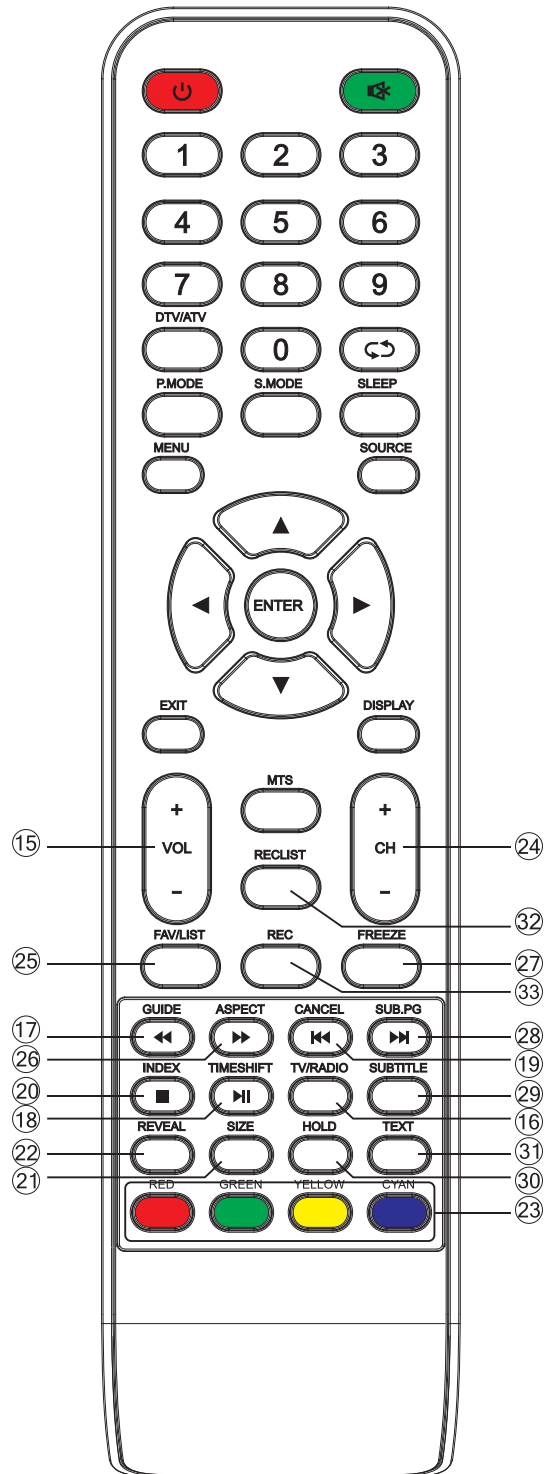

## Using the Remote Control:

Unless stated, the remote control can operate all the features of the TV.

Always point the remote control directly at the remote sensor in front of the TV.

## NOTICE CONCERNING RECYCLING



Your product is designed and manufactured with high quality materials and components which can be recycled and reused.

This symbol means that electrical and electronic equipment, at their end-of-life, should be disposed of separately from your household waste. Please dispose of this equipment at your local community waste collection/ recycling centre.

In the European Union there are separate collection systems for used electrical and electronic products. Please help us to conserve the environment we live in!

## DECLARATION OF CONFORMITY

Herewith we state that this product complies with the requirements of below directives:

RED Directive 14/53/EU

ErP Directive 09/125/EC

RoHS Directive 11/65/EU

amended by the CE-marking Directive 93/68/EEC

The detailed declaration of conformity can be found at [www.fandu.gr](http://www.fandu.gr)

### EXCLUSIVE IMPORTER IN GREECE:

**KALLIOPI KARYDA & CO LP**

87A, 17th November Str. | P.C. 55535

Pylea | Greece

T: 2316006600

Web: [www.fandu.gr](http://www.fandu.gr)